



**Features:**

- n Isolated mounting base 3000V~
- n Pressure contact technology with Increased power cycling capability
- n Space and weight saving

**Typical Applications**

- n Various rectifiers
- n DC supply for PWM inverter

V <sub>RRM</sub>	Type & Outline
800V	MDx200-08-216F3
1000V	MDx200-10-216F3
1200V	MDx200-12-216F3
1400V	MDx200-14-216F3
1600V	MDx200-16-216F3
1800V	MDx200-18-216F3
1800V	MD200-18-216F3G

MDx stands for any type of **MDC, MDA, MDK**

SYMBOL	CHARACTERISTIC	TEST CONDITIONS	T <sub>j</sub> (°C)	VALUE			UNIT
				Min	Type	Max	
I <sub>F(AV)</sub>	Mean forward current	180° half sine wave 50Hz Single side cooled, T <sub>c</sub> =100°C	150			200	A
I <sub>F(RMS)</sub>	RMS forward current					314	A
I <sub>RRM</sub>	Repetitive peak current	at V <sub>RRM</sub>	150			12	mA
I <sub>FSM</sub>	Surge forward current	V <sub>R</sub> =60%V <sub>RRM</sub> , t=10ms half sine.	150			7.5	kA
I <sup>2</sup> t	I <sup>2</sup> t for fusing coordination					281	10 <sup>3</sup> A <sup>2</sup> s
V <sub>FO</sub>	Threshold voltage		150			0.75	V
r <sub>F</sub>	Forward slope resistance					0.88	mΩ
V <sub>FM</sub>	Peak forward voltage	I <sub>FM</sub> =600A	25			1.38	V
R <sub>th(j-c)</sub>	Thermal resistance Junction to case	Single side cooled per chip				0.21	°C/W
R <sub>th(c-h)</sub>	Thermal resistance case to heatsink	Single side cooled per chip				0.08	°C/W
V <sub>iso</sub>	Isolation voltage	50Hz, R.M.S, t=1min, I <sub>iso</sub> :1mA(MAX)		3000			V
F <sub>m</sub>	Terminal connection torque(M6)			4.5		6.0	N·m
	Mounting torque(M6)			4.5		6.0	N·m
T <sub>vj</sub>	Junction temperature			-40		150	°C
T <sub>stg</sub>	Stored temperature			-40		125	°C
W <sub>t</sub>	Weight				320		g
Outline	216F3						

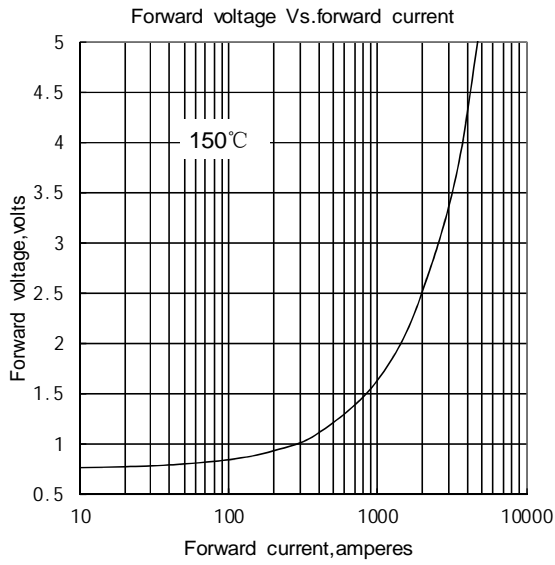

Fig.1

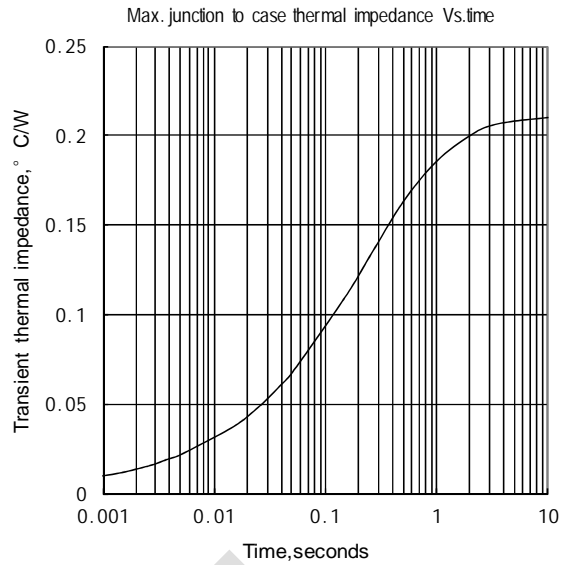

Fig.2

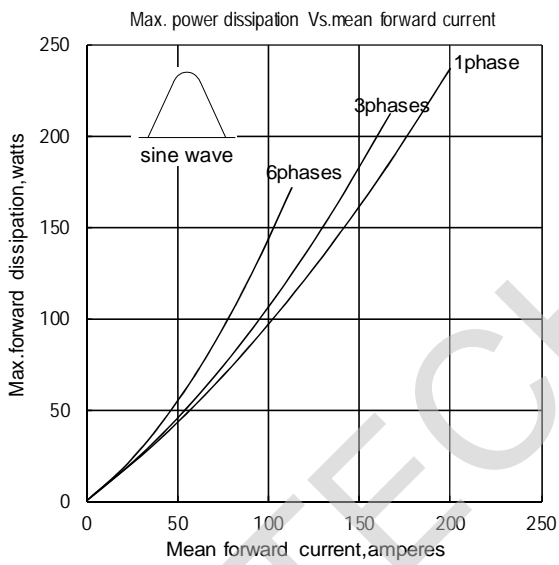

Fig.3

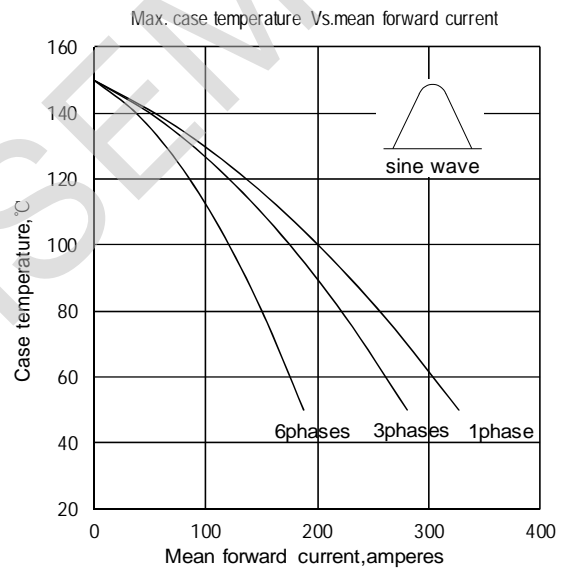

Fig.4

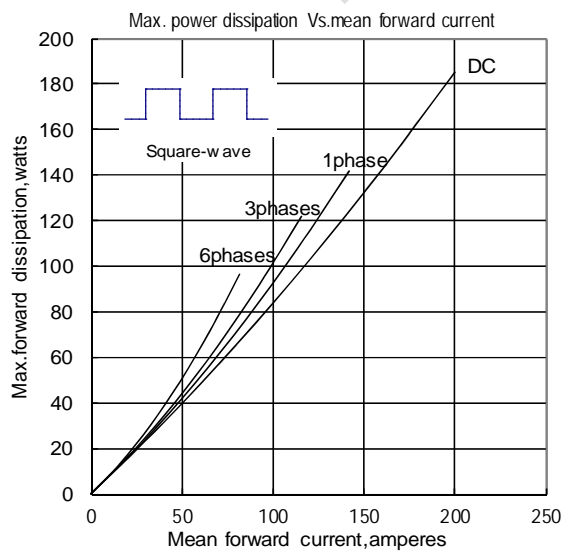

Fig.5

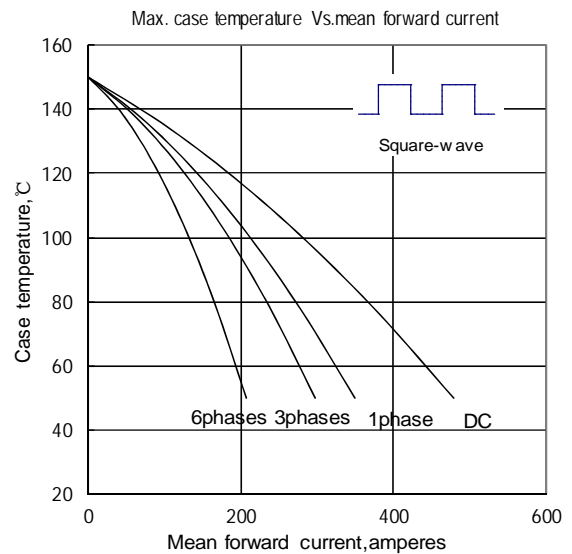

Fig.6

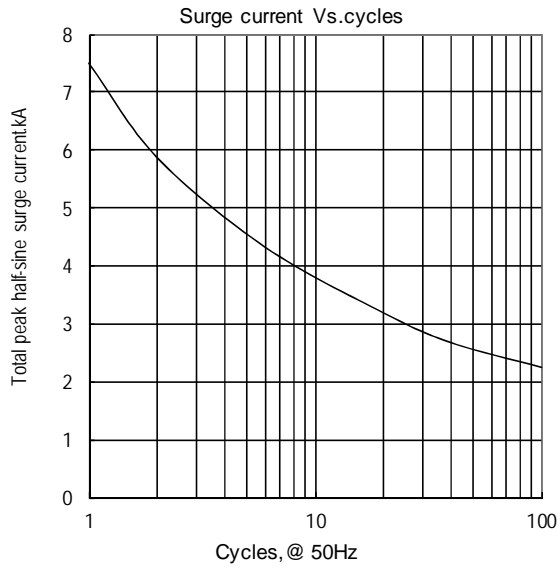

Fig.7

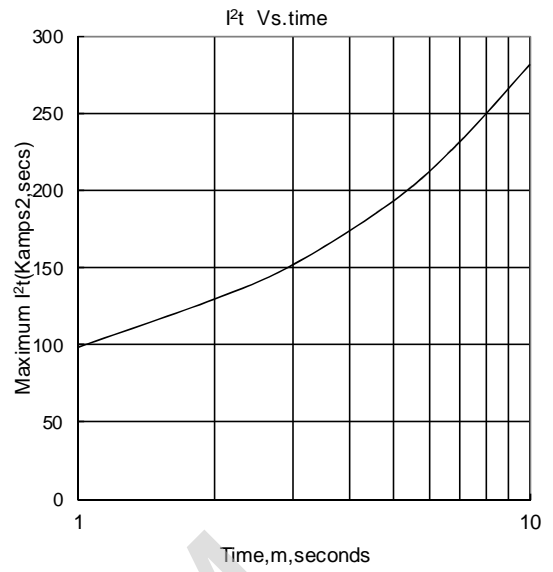
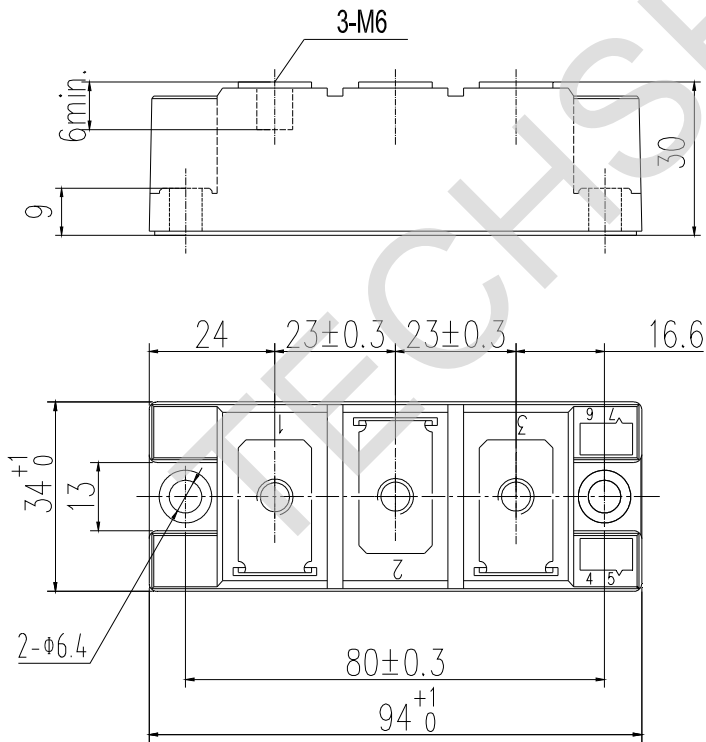

Fig.8

Outline:



Unmarked dimensional tolerance: ±0.5mm

